

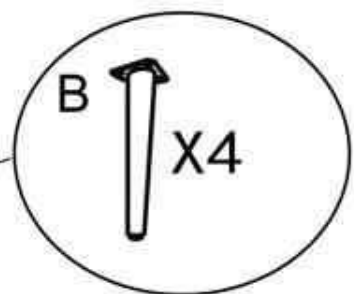

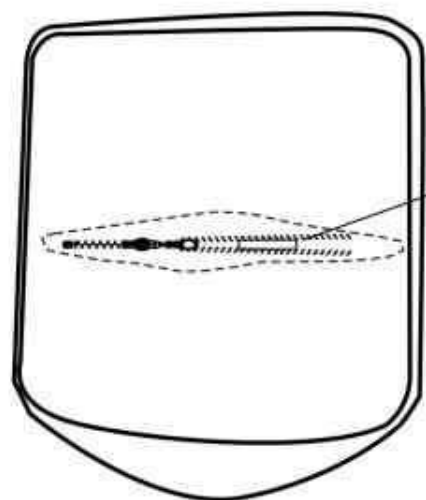

# GRIFON 2

1

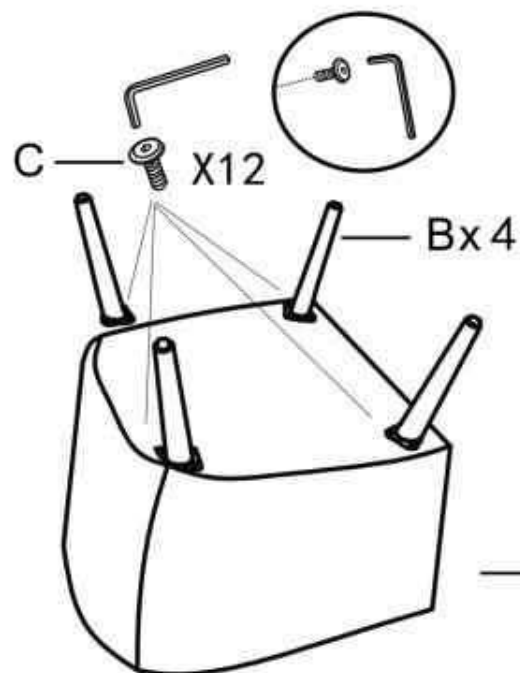

2

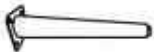

A		1
B		4
C	 M6x20 mm	12

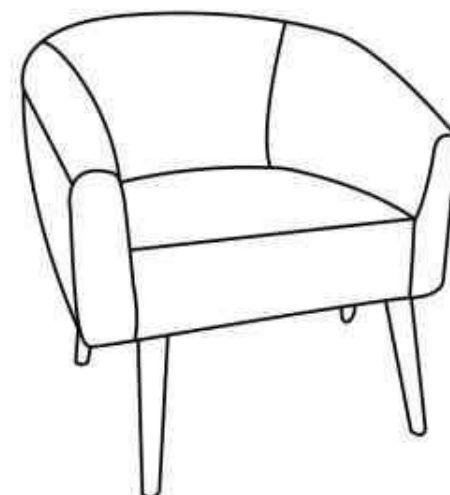

 max. 100 kg