

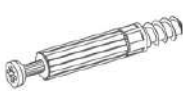





<p>H</p>  <p>8x</p>	<p>I</p>  <p>12x</p>	<p>J</p>  <p>$\phi 8 \times 35 \text{mm}$ 20x</p>
<p>M</p>  <p>4x</p>	<p>K</p>  <p>12x</p>	<p>P</p>  <p>2x</p>

1



2

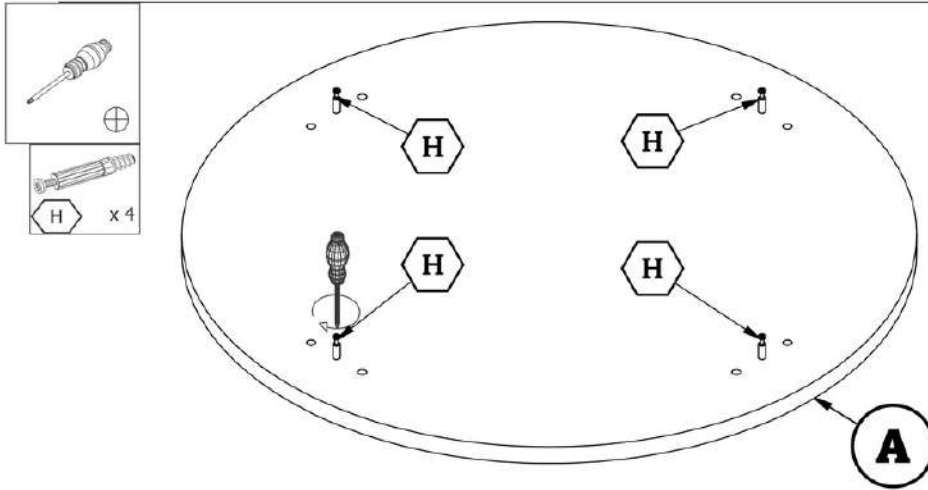
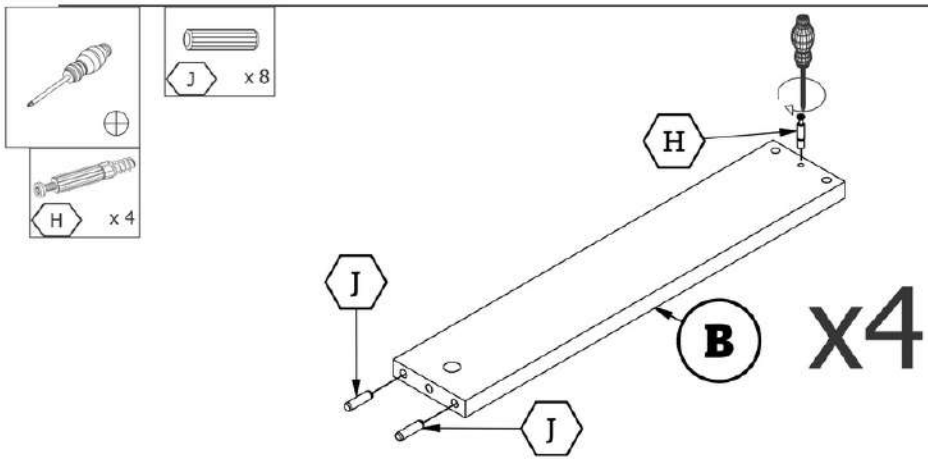

3

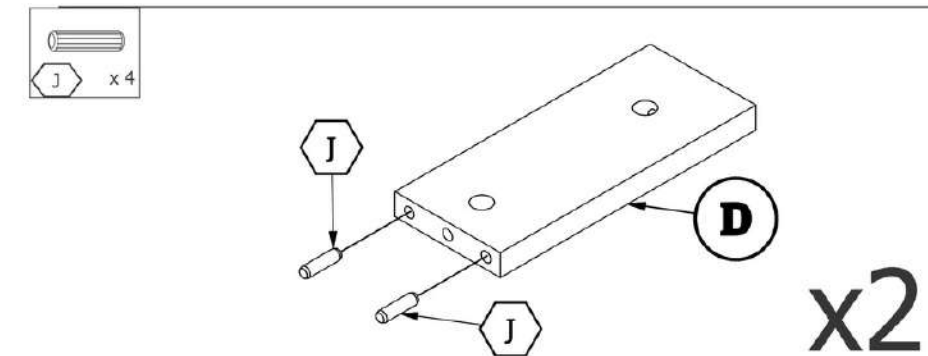

4

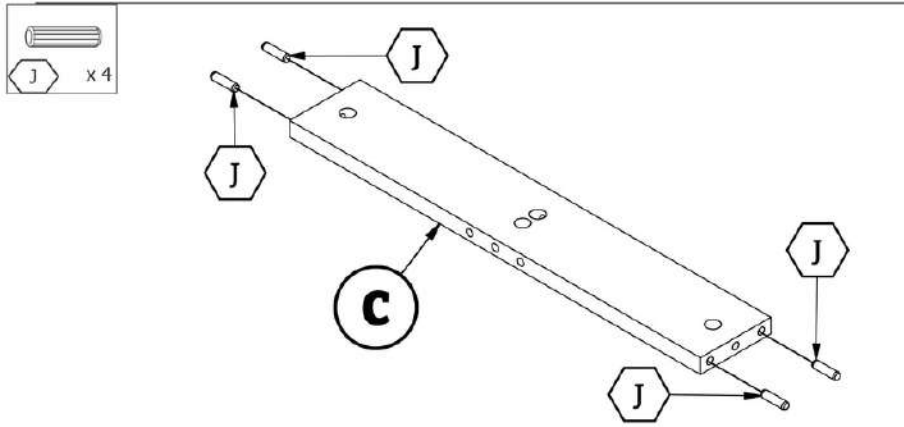

5

